

# SM1L43

Unit: mm

## AC POWER CONTROL APPLICATIONS

- Repetitive Peak Off-State Voltage :  $V_{DRM} = 800V$
- R.M.S. On-State Current :  $I_T (RMS) = 1A$

## MAXIMUM RATINGS

CHARACTERISTIC	SYMBOL	RATING	UNIT
Repetitive Peak Off-State Voltage	$V_{DRM}$	800	V
R.M.S. On-State Current (Full Sine Waveform $T_c = 74^\circ C$ )	$I_T (RMS)$	1.0	A
Peak One Cycle Surge On-State Current (Non-Repetitive)	$I_{TSM}$	8 (50Hz)	A
		8.8 (60Hz)	
$I^2t$ Limit Value ( $t = 1\sim 10ms$ )	$I^2t$	0.32	$A^2s$
Peak Gate Power Dissipation	$P_{GM}$	1	W
Average Gate Power Dissipation	$P_G (AV)$	0.1	W
Peak Gate Voltage	$V_{GM}$	6	V
Peak Gate Current	$I_{GM}$	0.5	A
Junction Temperature	$T_j$	-40~125	$^\circ C$
Storage Temperature Range	$T_{stg}$	-40~125	$^\circ C$

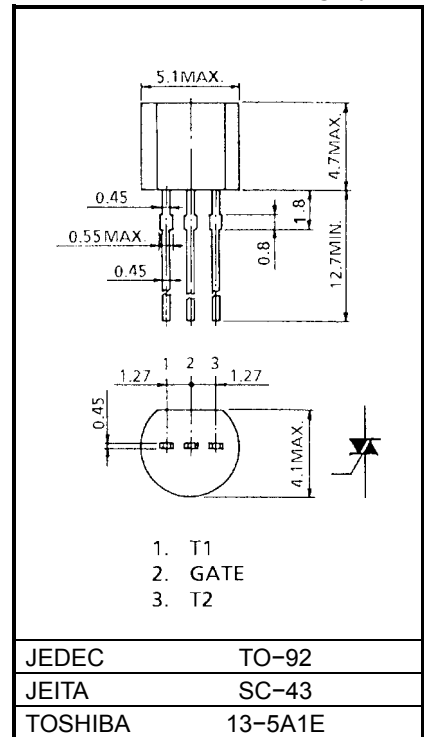



Weight: 0.2g

## ELECTRICAL CHARACTERISTICS (Ta = 25°C)

CHARACTERISTIC	SYMBOL	TEST CONDITION	MIN	TYP.	MAX	UNIT	
Repetitive Peak Off-State Current	$I_{DRM}$	$V_{DRM} = 800V$	—	—	10	$\mu A$	
Gate Trigger Voltage	I	$V_D = 12V,$ $R_L = 20\Omega$	T2 (+), Gate (+)		—	1.5	V
	II		T2 (+), Gate (-)		—	1.5	
	III		T2 (-), Gate (-)		—	1.5	
Gate Trigger Current	I	$V_D = 12V,$ $R_L = 20\Omega$	T2 (+), Gate (+)		—	10	mA
	II		T2 (+), Gate (-)		—	10	
	III		T2 (-), Gate (-)		—	10	
Peak On-State Voltage	$V_{TM}$	$I_{TM} = 1.5A$	—	—	1.5	V	
Gate Non-Trigger Voltage	$V_{GD}$	$V_D = \text{Rated}, T_c = 125^\circ C$	0.2	—	—	V	
Holding Current	$I_H$	$V_D = 12V, I_{TM} = 1A$	—	—	10	mA	
Thermal Resistance	$R_{th(j-c)}$	Junction to Case, AC	—	—	40	$^\circ C / W$	
Thermal Resistance	$R_{th(j-a)}$	Junction to Ambient, AC	—	—	180	$^\circ C / W$	

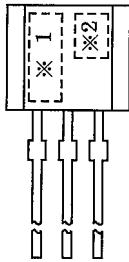
## MARKING



NUMBER	SYMBOL	MARK
*1	TYPE	SM1L43
*2	Lot Number  Month (Starting from Alphabet A) Year (Last Decimal Digit of the Current Year)	Example 8A : January 1998 8B : February 1998 8L : December 1998

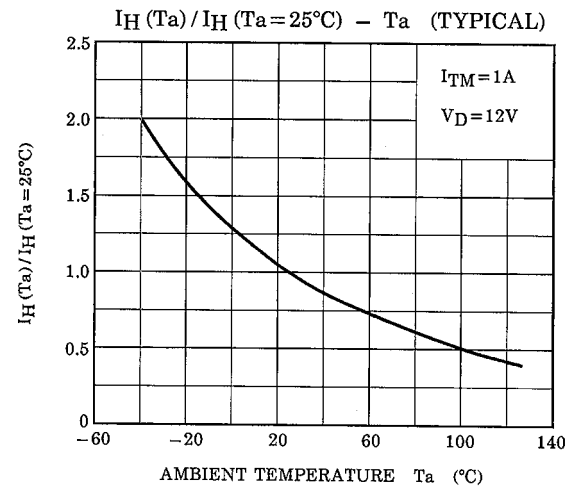
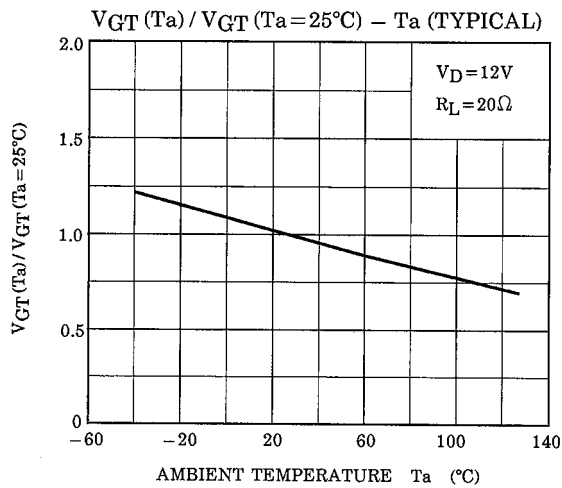
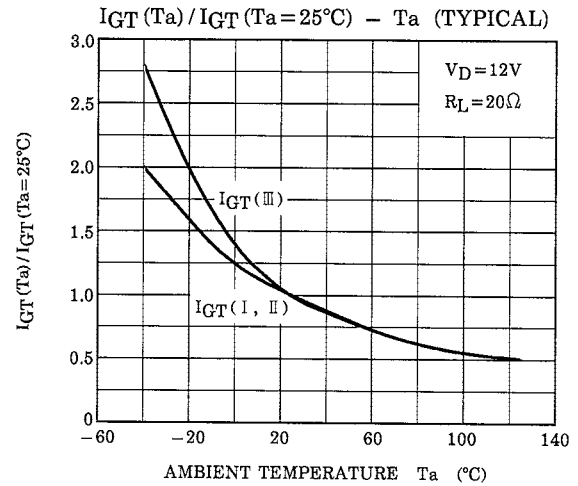
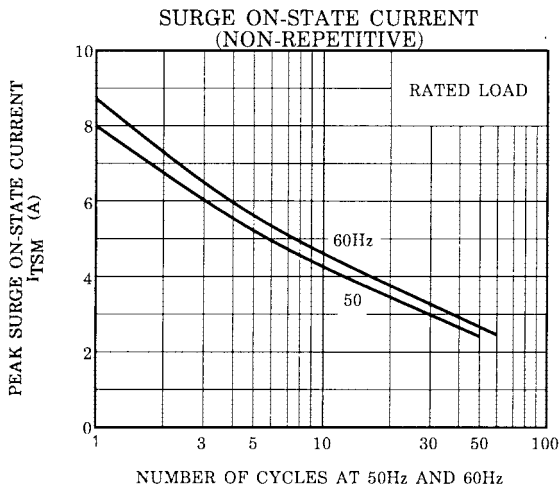
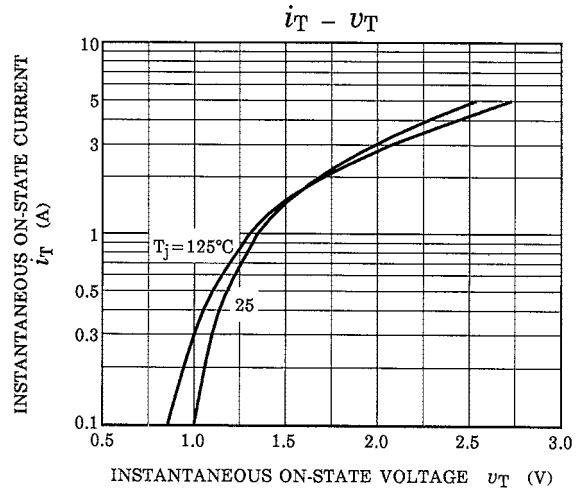
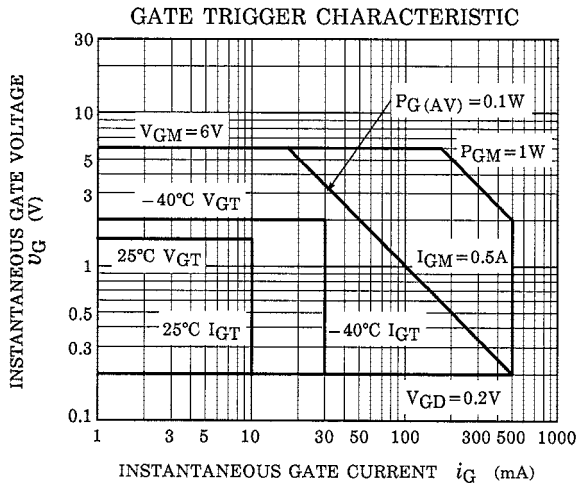

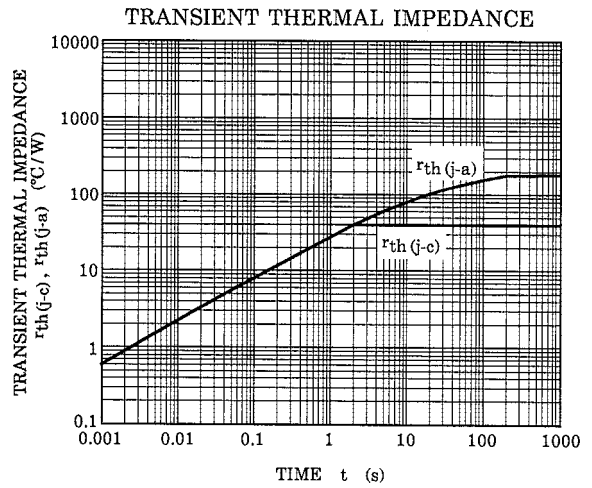
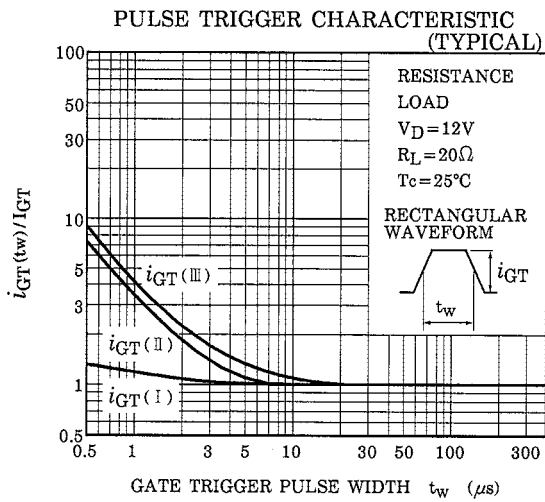
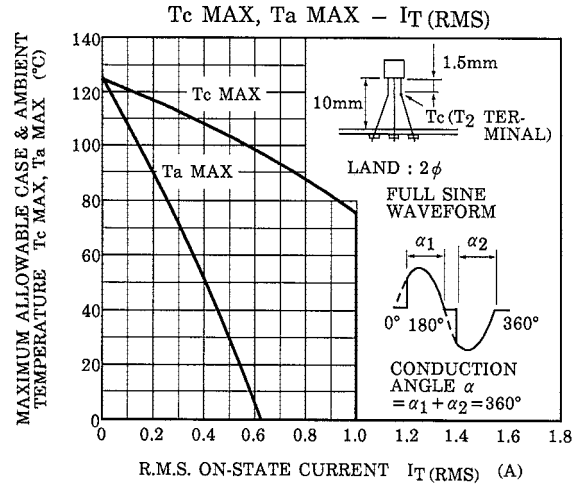
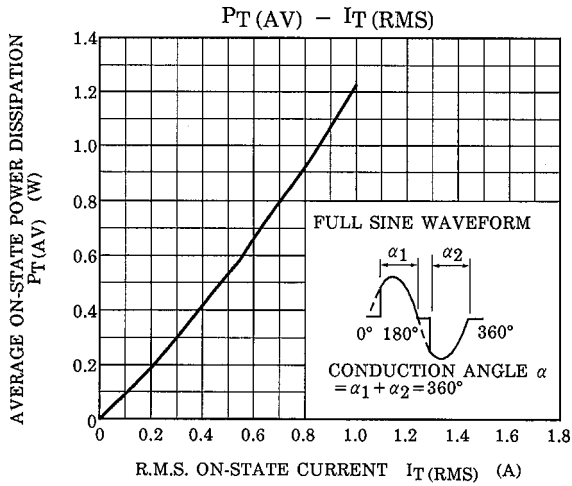

**RESTRICTIONS ON PRODUCT USE**

000707EAA

- TOSHIBA is continually working to improve the quality and reliability of its products. Nevertheless, semiconductor devices in general can malfunction or fail due to their inherent electrical sensitivity and vulnerability to physical stress. It is the responsibility of the buyer, when utilizing TOSHIBA products, to comply with the standards of safety in making a safe design for the entire system, and to avoid situations in which a malfunction or failure of such TOSHIBA products could cause loss of human life, bodily injury or damage to property.  
In developing your designs, please ensure that TOSHIBA products are used within specified operating ranges as set forth in the most recent TOSHIBA products specifications. Also, please keep in mind the precautions and conditions set forth in the "Handling Guide for Semiconductor Devices," or "TOSHIBA Semiconductor Reliability Handbook" etc..
- The TOSHIBA products listed in this document are intended for usage in general electronics applications (computer, personal equipment, office equipment, measuring equipment, industrial robotics, domestic appliances, etc.). These TOSHIBA products are neither intended nor warranted for usage in equipment that requires extraordinarily high quality and/or reliability or a malfunction or failure of which may cause loss of human life or bodily injury ("Unintended Usage"). Unintended Usage include atomic energy control instruments, airplane or spaceship instruments, transportation instruments, traffic signal instruments, combustion control instruments, medical instruments, all types of safety devices, etc.. Unintended Usage of TOSHIBA products listed in this document shall be made at the customer's own risk.
- The information contained herein is presented only as a guide for the applications of our products. No responsibility is assumed by TOSHIBA CORPORATION for any infringements of intellectual property or other rights of the third parties which may result from its use. No license is granted by implication or otherwise under any intellectual property or other rights of TOSHIBA CORPORATION or others.
- The information contained herein is subject to change without notice.